



SOLUTIONIX
PART OF **MEDIT** METROLOGY GROUP

What's new in Solutionix's scanners?

Solutionix provides fully automated 3D scanning solutions for both small and medium sized objects. With a powerful scan engine and affordable pricing, the new scanners are a perfect fit for both performance enthusiasts and entry level users.

Simple, Smart yet Powerful **Solutionix C500**

C500 is ideally designed for optimal scanning of small and medium sized objects in a highly accurate and fully automated way.



Precise, Flexible, Convenient **Solutionix D500**

D500 is professional 3D scanner system specifically designed to scan small objects with complex shapes requiring fine details to be scanned with precision.



ezScan 2017 – Rediscover your productivity with state-of-the-art software technology

The new Solutionix's scanners works hand-in-hand with the all new ezScan 2017 software.

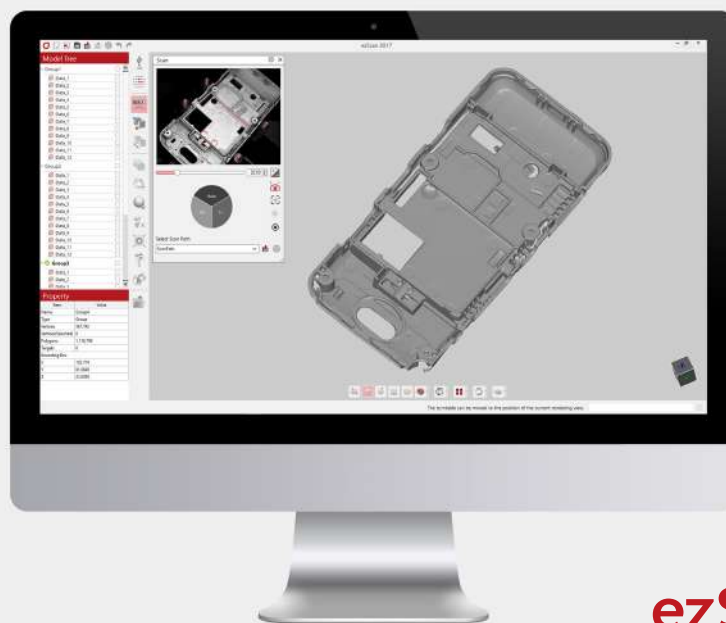

ezScan 2017

Solutionix C500

High-performance yet cost-effective solution that opens up a new dimension in efficient 3D data acquisition.

It actually is as easy as it looks!

3D data acquisition with the Solutionix C500 is particularly fast. The speedy measurement time and intuitive, user friendly software 'ezScan 2017' allows you to maximize your efficiency and work productivity.

Solutionix C500 adopts Blue light technology which enables user to obtain extremely detailed scan data. In addition, the design of C500 is compact despite having an built-in controller, so it will take up minimum space, leaving room for user to utilize on other work.

Optimized for acquiring high-quality 3D scan data

Solutionix C500 consists of premium high resolution cameras that maximizes the quality of 3D scan data. To overcome the restriction implied by the size of object to scan, C500 provides user with 3 different scanning areas (90 ~ 350mm). C500 also includes 3-axis turntable, allowing users of all level to work easily and efficiently.

New API for customized integration

Users can use the API provided by Solutionix to control C500 and process its scan data. Furthermore, it is possible to make user's own scan application programs using various software and plug-in process.



Fast and easy scan work with maximum efficiency

Stress free 3D Scan preparation is one click away

No more confusing and time consuming calibrations. Once the calibration panel is installed, simply click the calibration wizard which will guide you through an automated calibration process. Targets are no longer needed for your scanning job with Solutionix's C500.

Using the pre-calculated information of the axis calibration, accurate alignment is carried out without the need for targets or manual registration. Now users can experience one-click automatic calibration easy enough for anyone in the office.

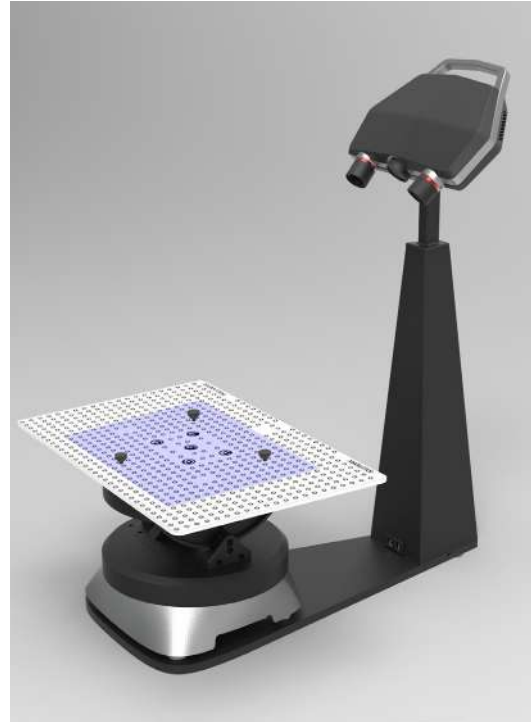

Quick and easy auto scan for all users

Users can complete the scan of their whole object easily and quickly with C500. Solutionix's 3-axis turntable (TA300+) can effectively capture areas beyond the pre existing limits. TA300+ is optimized for automatic scanning of small and medium sized objects. It can hold objects up to 10kg in weight and 380 mm X 320 mm (W X H) in size. Thanks to the TA300+, it is possible to work in cramped conditions without any difficulty.

- ❶ Rotation Axis : Provides $\pm 180^\circ$ movement
- ❷ Rotation (Base) Axis : Provides $\pm 180^\circ$ movement
- ❸ Swing Axis : Provides $\pm 40^\circ$ movement

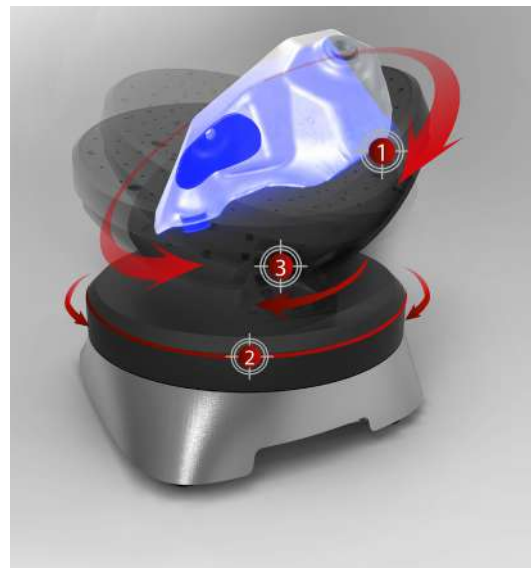

The perfect solution for all application

Quality Inspection

Utilizing 3D scan data, you can experience an automated quality control process. Compare measurements to the nominal CAD model and create color coded deviation maps of the errors in 3D. Identify and find solutions to any potential structural & functional defect by modeling the system or product in a virtual environment.

- 3D correction & improvement
- Tooling Inspection
- Process optimization & Automation
- Nominal & Actual comparison (CAD)
- Geometric dimensioning & Tolerancing (GD&T)

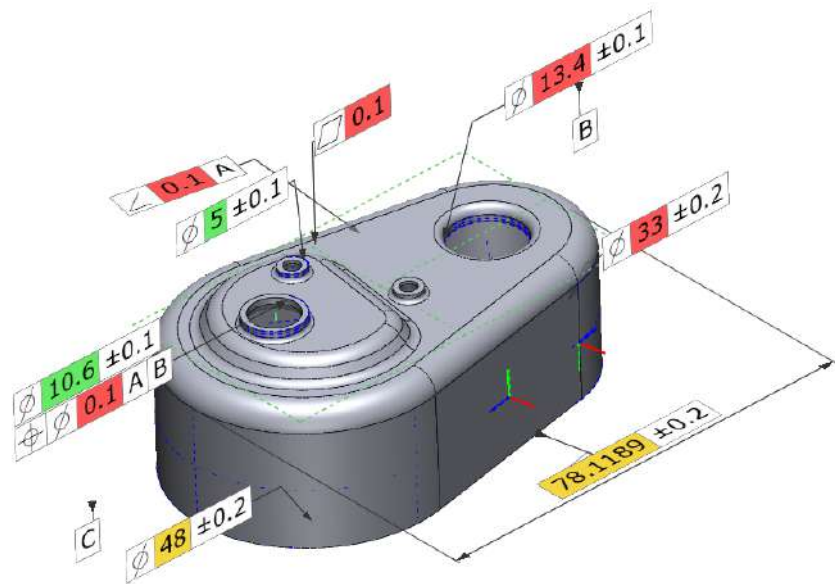

Reverse Engineering

Reverse engineering enables you to rectify tooling data, to transfer product developments into mass production in a time and cost saving manner, or to quickly and easily transfer older objects of which 3D data sets are not yet available in the CAD environment.

Additionally, you can produce detailed pieces in various materials with seamless data integration.

- System engineering
- Rapid prototyping
- 3D modeling & printing
- Document & archiving

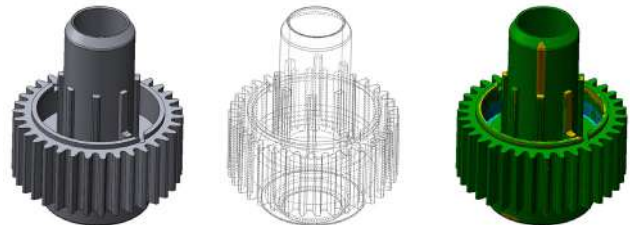

Technical Data

Solutionix C500 is available with different levels of detail. The measuring areas of this sensor can be changed easily, covering a range of different part size.

Section	Solutionix C500	Remark
Resolution	2 x 5 Mpx	
Measuring area (mm)	90 / 175 / 350	
Point spacing (mm)	0.028 / 0.056 / 0.110	
Dimensions (mm)	315 x 270 x 80	Scanner head only
Weight	Approx. 2 kg	Scanner head only
Interface	USB 3.0 B type	
Accessories	3-Axis turntable	2 Rotation / 1 Swing

Solutionix D500

D500 is professional 3D scanner system specifically designed to scan small parts with complex shapes.

Quality and Speed 3D scanning for small object

Solutionix D500 is a tool created to scan small models in a completely automated way.

The technical specifications of the D500 scanner are calculated to meet the high level of detail required by both industrial and non-industrial applications such as jewelry, cultural artifacts and design.

Scan for Small object – The process

- Position the object and start the scanning process
- The object is automatically captured from different direction in order to achieve the whole profile of complex shapes
- At the end of the procedure you will have a triangle mesh (.STL .OBJ) that can be imported to CAD-CAM systems.



Advanced precise color texture

The latest technology captures vivid color texture in scan data without the need for an additional color camera. Users can select the data processing method depending on the color of object to be scanned.



Technical Data

Section	Solutionix D500
Resolution	2 x 2 Mpx
Measuring area (mm)	120
Point spacing (mm)	0.056
Dimensions (mm)	290 x 290 x 340
Weight	Approx. 12 kg
Interface	USB 3.0 B type

ezScan 2017

Rediscover your productivity with state-of-the-art software technology

Automatic scanning solution

User can complete the scanning process quickly and easily. ezScan 2017 has an easier to use interface. Each scan processing has never been easier as each function is laid out in clearer way to reduce errors and increase speed. Smart scan is a new feature in ezScan 2017 which automatically finds 10 paths that wasn't properly scanned in the auto scan and perform additional scans automatically. If users still want to scan additional sections, they can easily do so by using the 'Active sync'. Active sync easily synchronizes the scan image view on the screen with the actual object on the scanner to the same view so it's intuitive and easier than ever to operate.

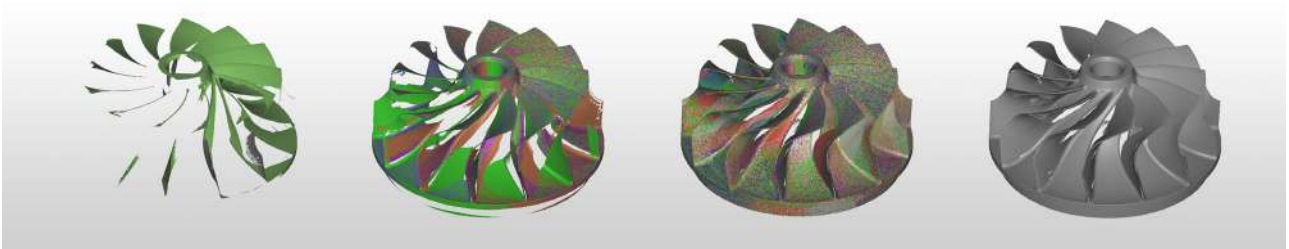

Enhanced scan data processing

ezScan 2017 provides superior scan data processing with an improved merge algorithm. It allows easy processing of parts(areas) that are difficult to obtain adequate scan data. Through functions such as watertight scan data form, scan data suitable for 3D printing, and analysis can easily be exported without using another design software.

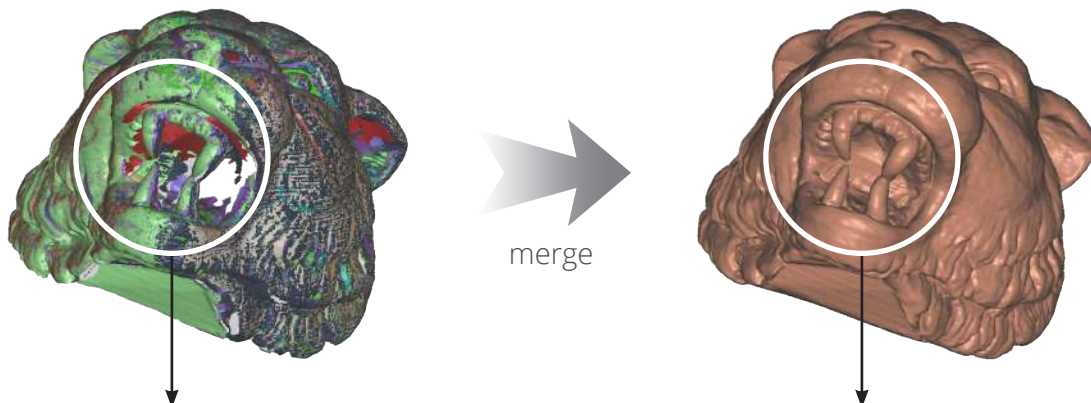

The deep and narrow part of object is difficult to obtain scan data.

Recovers fine details from noisy or sparse scan data and intelligently detects holes, and automatically fills the holes.

About Solutionix

Since our foundation in 2000, Solutionix, a part of Medit has worked to improve and revolutionize 3D imaging technology for industrial fields. We strive to create the highest quality products for our customers while also working to bring down cost. Because of this, we have produced some the most advanced and most affordable 3D scanners on the market. Solutionix has achieved double-digit annual growth over several years through unparalleled technology and creative product development with the aim to maximize client convenience. Developing our own patented state-of-the-art technology, Solutionix's mission is to provide the opportunity of success and growth to both our clients and employees.