

EinScan-SP

Platinum Desktop 3D Scanner



Quick Start Guide

Getting Started with EinScan-SP

Preparation

Unpacking Checklist

① Scanner Head	② Turntable	③ Scanner Stand
④ Scanner Bracket	⑤ Calibration Board	⑥ Calibration Board Holder
⑦ Power Cord	⑧ Power Adapter	⑨ USB Cable A
⑩ USB Cable B	⑪ Tripod	⑫ Reference Points
⑬ Quick Guide		

PC Requirement

Please prepare the PC with the following system requirement.

Operating System:	Win7 / 8 / 10 / 64bit
Port:	at least One USB2.0 / 3.0 port
RAM:	> 16 G
Graphic Card:	NVIDIA Series, GTX660 or better
Graphic Memory:	> 2 G
CPU:	i5 or higher

Scanner Assembly

Turntable Assembly

Place the turntable onto scanner stand

STEP 01

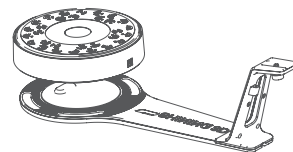

Scanner Head Assembly

Place the scanner head onto the bracket.

STEP 02

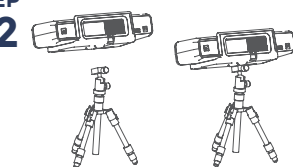
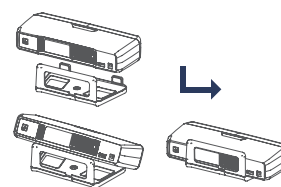

Setting Scanner on Tripod for Fixed Scan mode.

Screw the scanner head onto tripod.

Screw the scanner into the socket on the stand.

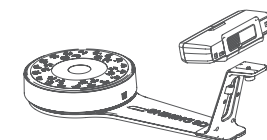

Connect the Scanner to Turntable

Plug USB cable into back of scanner, and turntable.

STEP 03

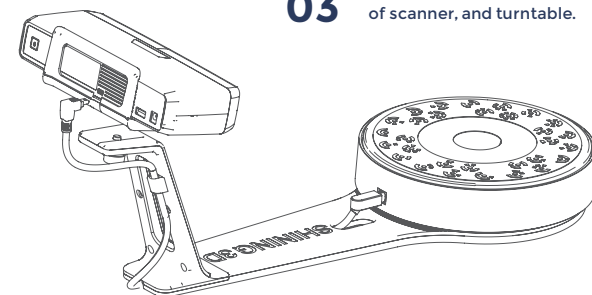

Scanner Assembly

STEP 04

Connect the Scanner to a Computer
Plug USB cable into back of scanner and computer USB port.

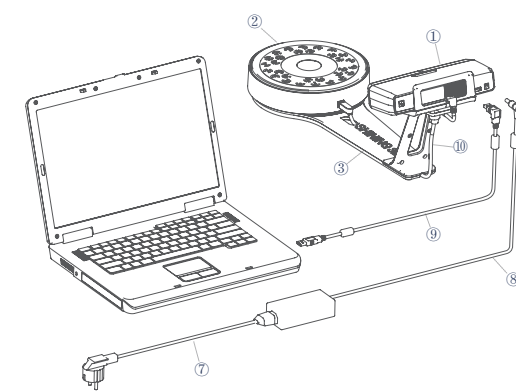

STEP 05

Connect the Power Supply
Plug power cord into outlet and the back of scanner.

STEP 06

Turn on the Scanner

Press the touch switch for 1 second to turn the scanner on.

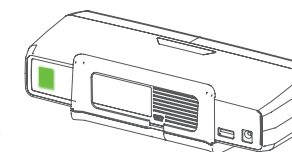

Software Installation

Software Download

Download software and user manual from <http://www.einscan.com/software-download>

STEP 01

Download & Service



Run the Installer

Double click to run the installation wizard and follow the installation instructions.

STEP 02

STEP 03

License Acquisition

During installation, you need to obtain license file online to activate your scanner. Make sure the scanner has been connected well and your computer is networking so as to detect your computer and validate your license.

Online Activation

If you fail to get license online, please contact your supplier or mail your scanner serial number (Sticker on the back of the scanner head) to einscan_support@shining3d.com to get the license file. Save the license file to your desktop. Click "Local Activation" and browse the license file and "Import".

Online Activation

Local Activation

Calibration

Calibration Board Assembly

Insert calibration board onto the board holder.

STEP 01

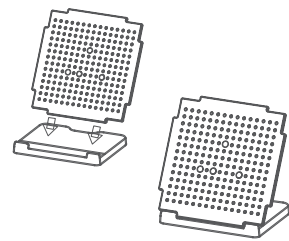

STEP 02

Calibration Board Placement

Place the calibration board on the center of the turntable facing the scanner.

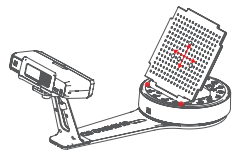

STEP 03

Run the Calibration

Open software, choose your scanner model of EinScan-SP and go to NEXT. Getting started with calibration button, following the on-screen instructions to turn the calibration board in 3 directions.
NOTE: Rotate the calibration board only during calibration.

Calibration Tips

You should calibrate the scanner in the initial set-up, or IF YOU MOVE THE SCANNER OR TURNABLE.

When you find the scanned quality is not as good as initial set-up, you can recalibrate your scanner.

Calibration needed when alignment mistake or failure frequently appear during the scanning.

How to Get a Successful Scan

What Can Be Scanned?

Great to Scan Under Auto Scan Mode



- Objects larger than 30*30*30 mm (1.2*1.2*1.2 in)
- Objects smaller than 250*250*250 mm (38*38*38 in)
- Object weighing less than 5 kg (11 lbs)



Difficult to Scan

- Transparent objects like glass
- Shining or reflective objects like varnished metal parts
- Dark color object like black keyboard
- Fuzzy objects like hair
- Solution: Painting white powder on objects will improve the scan quality.



Do NOT Suggest to Scan

- Moving objects
- Hollow pattern object like Eiffel Tower souvenirs
- Objects smaller than 30*30*30 mm (1.2*1.2*1.2 in)



Note: If the size and weight of the object are out as mentioned above, please scan on tripod without turntable by Fixed Scan Mode.

Our Scan Process

Build Project

Click "New Project" button to start a new scan.

STEP 01



Texture Scan Option

Choose texture scan if color texture is needed for scanning. Or, choose non-texture scan (Texture scan is taking little longer time, and white balance test should be done before texture scanning).



STEP 02

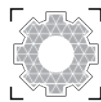

Place Object

Make sure the object is stable during the scanning.

STEP 03



Bright



Dark or difficult to scan

STEP 04



Bright & Dark



Medium

Adjust Brightness

Choose the brightness setting according to your object surface condition. Too much red appears on the object shown in the window means over bright.
Note: Please check the exposure instruction in user manual.

Scan

Click Scan button to start scanning.

STEP 05

Our Scan Process

Edit Scan

SHIFT+Left mouse: Select redundant data, the selected section will show as red. The tool bar on the top will allow you to do further edit.

STEP 06

Edit buttons:

- 1 Deselect
- 2 Revert
- 3 Delete
- 4 Undo
- 5 Show/Hide Stripes

Click to save data and exit the single-piece edition.

Complete the Scan in More Directions

STEP 07

Sometimes, if one rotate can't give you a full scan, you can place the object in other directions to capture the missing faces. After edit, save the current scanned data, the current data will be aligned to the last scanned data automatically.

Manual Alignment

If automatic alignment fail during scanning, you can use manual alignment. (Misalignment doesn't frequently happen. Please refer the detail of manual alignment in user manual)

STEP 08



Mesh

When the scan is completed, go mesh directly. Watertight or Unwatertight model can be selected due to your request.

STEP 09

Watertight is closed model which can be printed directly. Unwatertight model is a non-closed model keeping the missing scanned area as it is, which is usually chosen for further design purpose in other program.

Save

Asc, stl, obj and ply are available.

STEP 10

Press the touch switch for 1 second twice to turn the scanner off.



SHINING 3D®

HANGZHOU SHINING 3D TECH CO., LTD.

Email: sales@shining3d.com

Address: No.1398 Xiangbin Road, Wenyan Street, Xiaoshan District, Hangzhou, China

Support Contact

Skype: einscan_support

WhatsApp: +86 13738029764

Email: einscan_support@shining3d.com

www.einscan.com www.shining3d.com